



Pablo®

CORNER OFFICE

CORNER OFFICE

Today, every place is a workplace. Due to the constantly changing landscape of work, often our own offices can be as inconvenient, uninviting and distracting as anyplace else.

Corner Office is designed to enhance the flexibility and efficiency of today's open plan workplace by defining personal space in these dynamic environments. Corner Office contributes to motivation, efficiency and well-being; providing visual privacy, sound reduction, task lighting, and desktop power.

Corner Office represents a new type of product for productivity. Corner office is systemic and flexible, offering various degrees of privacy and power provision.

DESIGNER

Peter Stathis + Michael McCoy 2017

AWARDS:

2017 Interior Design Best of Year Award Winner

Interior Design HiP Award

Metropolis Likes Award

The Good Design Award

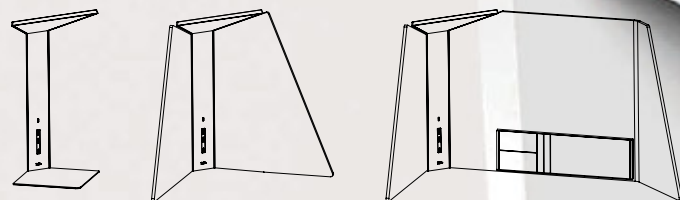



CORNER OFFICE LIGHT



CORNER OFFICE 15

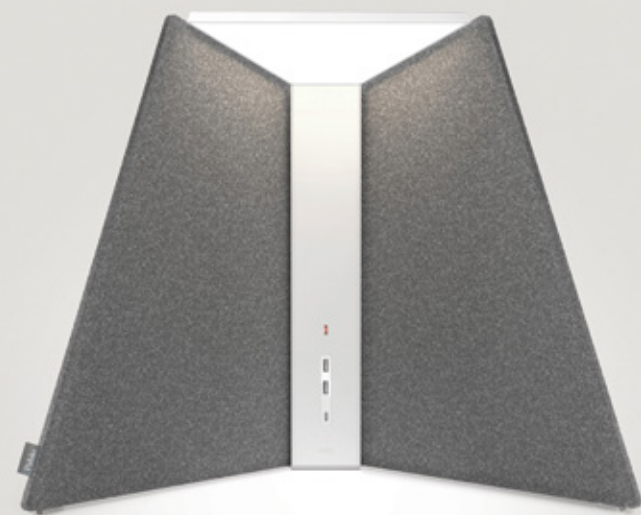

CONFIGURATIONS

Corner Office Light can be used alone as a minimal, space-efficient table lamp containing multiple device-charging ports. Corner Office 15 integrates the light with a semi-private acoustical corner panel, and Corner Office 30 incorporates a larger panel with all the features necessary for head down, intensive work and added privacy. Corner Office can be used independently, as light groupings, or as panel + light configurations.

Corner Office Light

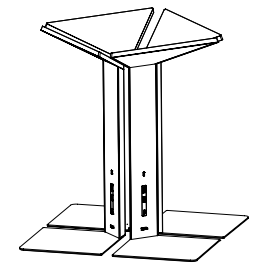
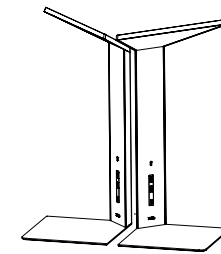
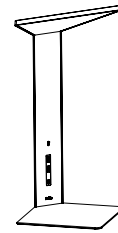

Corner Office 15

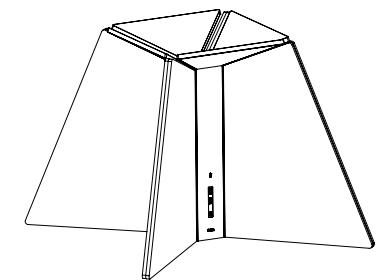
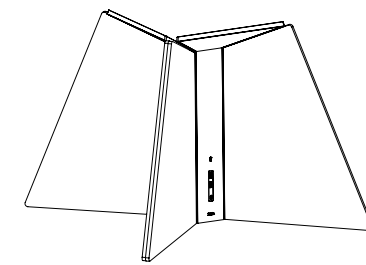
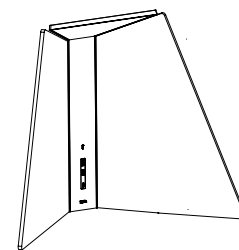

Corner Office 30

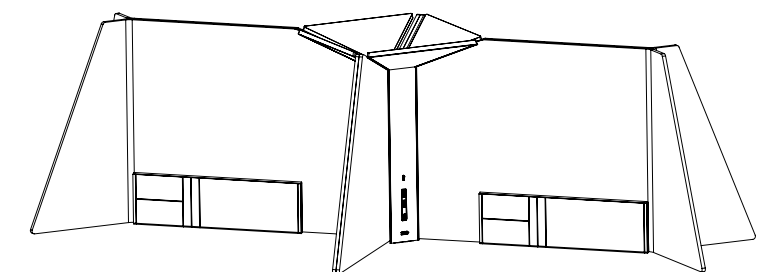
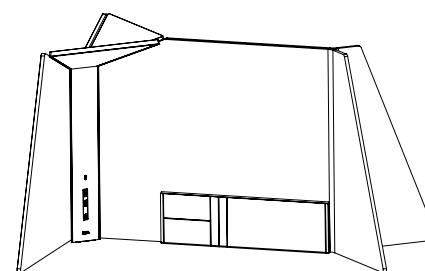
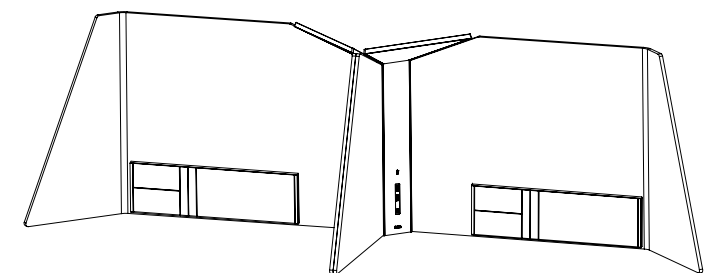
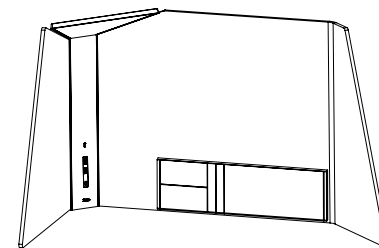

CORNER OFFICE 30



Corner Office System Panel*

Offers full privacy coverage for benching solutions up to 66" (168 cm) wide desks.

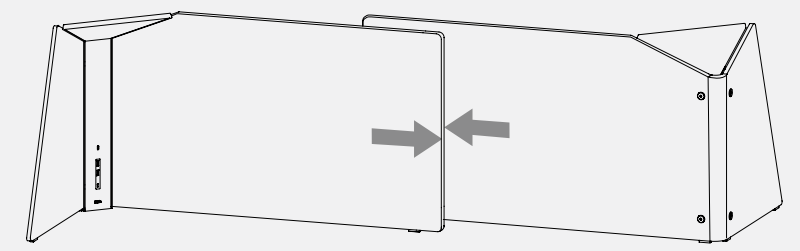
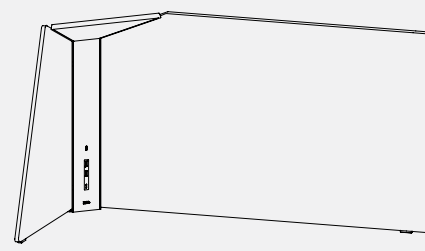

33.5" (85cm)

*Special Order: System Panel available upon request.

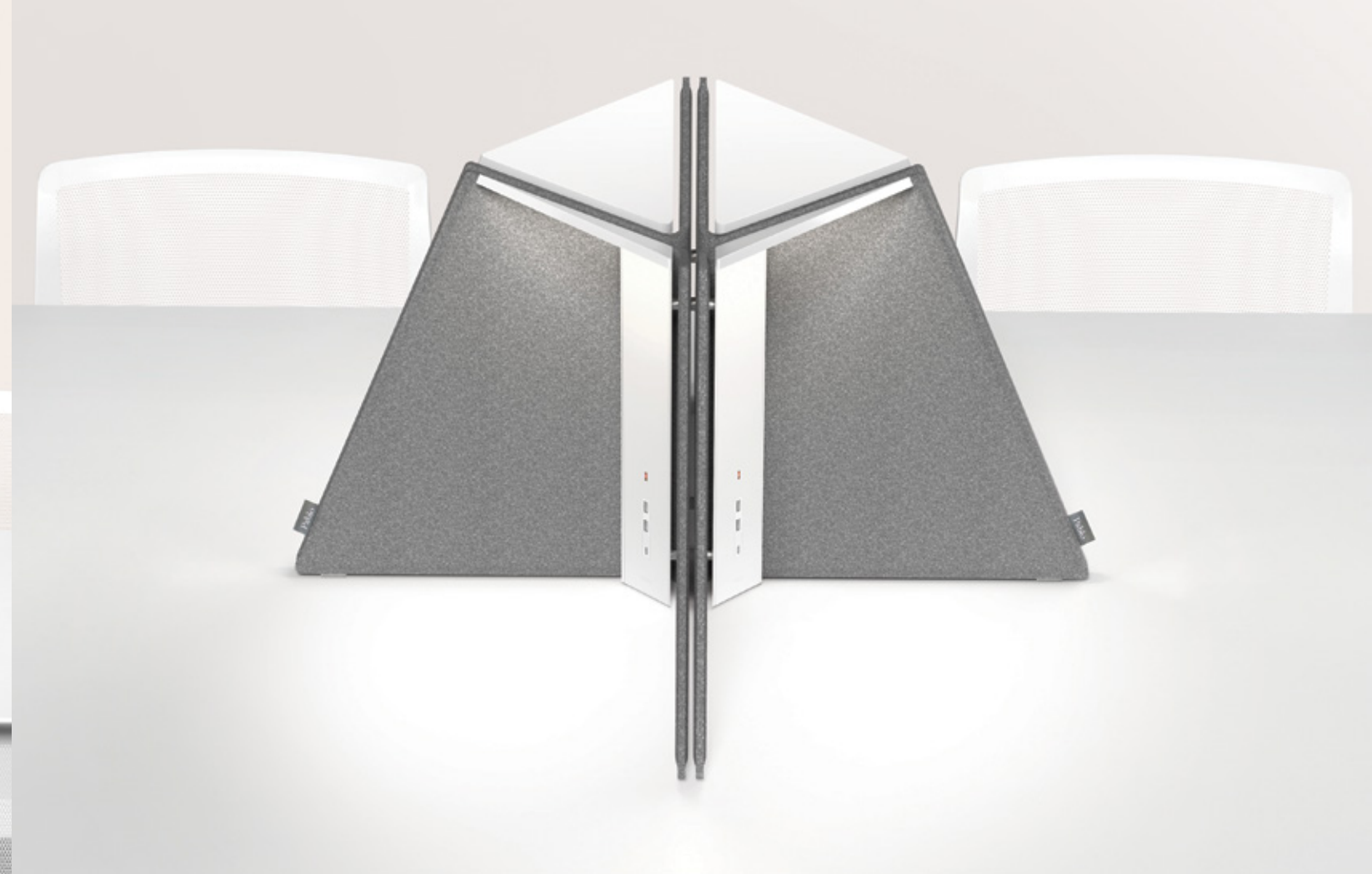



CORNER OFFICE

DESCRIPTION

Corner office is systemic and flexible, offering various degrees of privacy and power provision. The system comprises of three elements: a glare-free, fully dimmable LED corner task light that incorporates power ports featured in its armature; a set of optional acoustic deterrent fabric panels; and an optional pocket accessory that provides a place to store a phone or tablet, keeping things clutter-free. Easily reconfigurable, the system is light weight and easy to assemble and install.

LIGHT SOURCE

LED Flat-Panel

MATERIALS

- Aluminum lamp assembly
- Polycarbonate lens
- Steel Base
- Polyester panel

FEATURES

- Available with two sizes of interchangeable panels
- Panels are reversible with many possible configurations
- Light + power ports + visual privacy + sound dampening
- Optimally positioned warm glare-free LED illumination
- Fully dimmable with optical touch switch
- Reversible pocket accessory included
- 2 USB type A 3.0 - 10W Charging Ports
- 1 USB type C 3.1 - 35W Charging Port

SPECIFICATIONS

- Voltage: 120-240V 50/60Hz
- Power Consumption: LED - 8W, System Power - 63W
- Color Temperature: 3000K
- Luminosity: 600 lm
- Luminaire efficacy: 75 Lumens/Watt
- Color Rendition Index: 80 CRI
- 50K hour lifespan
- Cable Length: 10' (3M)

MODELS

- Corner Office 15
- Corner Office 30
- Corner Office Light

CERTIFICATION



NOTE

Customized panels available upon request

FINISHES



TURQUOISE



CHESTNUT



STONE GREY



ANTHRACITE

DIMENSIONS

CORNER OFFICE LIGHT

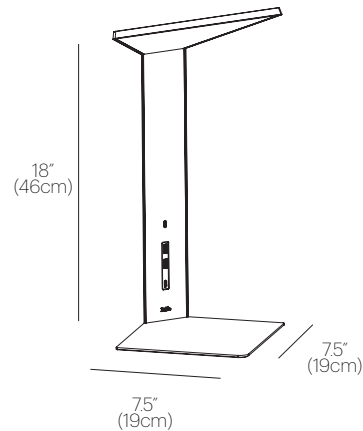

CORNER OFFICE 15

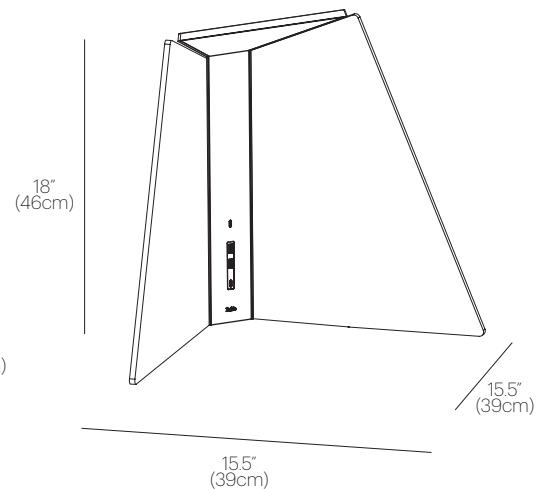

CORNER OFFICE 30

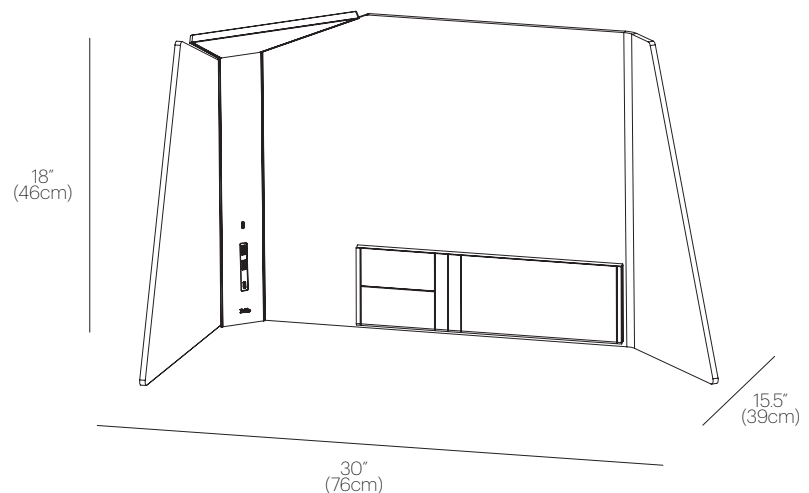

Pablo

PABLO
USA

888 MARIN STREET
SAN FRANCISCO, CA 94124
T: +1 415 865 5000
F: +1 415 865 0500
INFO@PABLODESIGNS.COM
PABLODESIGNS.COM

PABLO
EUROPE

Netherlands +31 85 888 0858
INFO@PABLODESIGNS.EU
PABLODESIGNS.EU